

DEEP GROOVE BALL BEARINGS

SINGLE-ROW DEEP GROOVE BALL BEARINGS

Open Type, Shielded Type, Sealed Type Bore Diameter 10 – 240mm B8
 Open Type Bore Diameter 260 – 800mm B20

MAXIMUM TYPE BALL BEARINGS Bore Diameter 25 – 110mm B26

MAGNETO BEARINGS Bore Diameter 4 – 20mm B28

Extra Small and Miniature Ball Bearings are described on Pages B30 to B45.



DESIGN, TYPES, AND FEATURES

SINGLE-ROW DEEP GROOVE BALL BEARINGS

Single-Row Deep Groove Ball Bearings are classified into the types shown below.

The proper amount of good quality grease is packed in shielded and sealed ball bearings. A comparison of the features of each type is shown in Table 1.

Table 1 Features of Sealed Ball Bearings

Type	Shielded Type (ZZ Type)	Non-Contact Rubber Sealed Type (VV Type)	Contact Rubber Sealed Type (DDU Type)
Torque	Low	Low	Higher than ZZ, VV types due to contact seal
Speed capability	Good	Good	Limited by contact seals
Grease sealing effectiveness	Good	Better than ZZ type	A little better than VV type
Dust resistance	Good	Better than ZZ type (usable in moderately dusty environment)	Best (usable even in very dusty environment)
Water resistance	Not suitable	Not suitable	Good (usable even if fluid is splashed on bearing)
Operating temperature ⁽¹⁾	-10 to +110°C	-10 to +110°C	-10 to +100°C

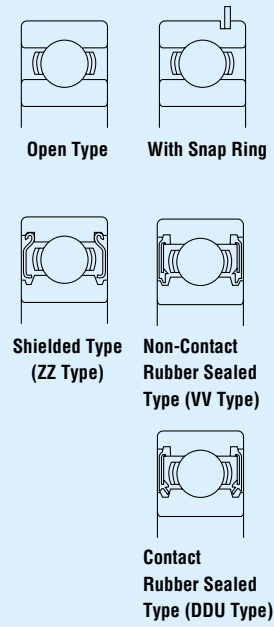

Note ⁽¹⁾ The above temperature range applies to standard bearings. By using cold or heat resistant grease and changing the type of rubber, the operating temperature range can be extended. For such applications, please contact NSK.

For deep groove ball bearings, pressed cages are usually used. For big bearings, machined brass cages are used. (Refer to Table 2)

Machined cages are also used for high speed applications.

Table 2 Standard Cages for Deep Groove Ball Bearings

Series	Pressed Steel Cages	Machined Brass Cages
68	6800 – 6838	6840 – 68/800
69	6900 – 6936	6938 – 69/800
160	16001 – 16026	16028 – 16064
60	6000 – 6040	6044 – 60/670
62	6200 – 6240	6244 – 6272
63	6300 – 6332	6334 – 6356

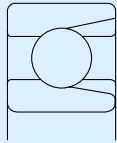

MAXIMUM TYPE BALL BEARINGS

Maximum Type Ball Bearings contain a larger number of balls than normal deep groove ball bearings because of filling slots in the inner and outer rings. Because of their filling slots, they are not suitable for applications with high axial loads.

BL2 and BL3 types of bearings have boundary dimensions equal to those of single-row deep groove ball bearings of Series 62 and 63 respectively. Besides the open type, ZZ type shielded bearings are also available.

When using these bearings, it is important for the filling slot in the outer ring to be outside of the loaded zone as much as possible.

Their cages are pressed steel.

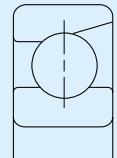

MAGNETO BEARINGS

The groove in the inner ring is a little shallower than that of deep groove ball bearings and one side of the outer ring is relieved. Consequently, the outer ring is separable, which makes it convenient for mounting.

Pressed cages are standard, but for high speed applications, machined synthetic resin cages are used.

PRECAUTIONS FOR USE OF DEEP GROOVE BALL BEARINGS

For deep groove ball bearings, if the bearing load is too small during operation, slippage occurs between the balls and raceways, which may result in smearing. The higher the weight of balls and cage, the higher this tendency becomes, especially for large bearings. If very small bearing loads are expected, please contact NSK for selection of an appropriate bearing.

TOLERANCES AND RUNNING ACCURACY

SINGLE-ROW DEEP GROOVE BALL BEARINGS	Table 8.2 (Pages A60 to A63)
MAXIMUM TYPE BALL BEARINGS	Table 8.2 (Pages A60 to A63)
MAGNETO BEARINGS	Table 8.5 (Pages A70 and A71)

RECOMMENDED FITS

SINGLE-ROW DEEP GROOVE BALL BEARINGS	Table 9.2 (Page A84)
	Table 9.4 (Page A85)
MAXIMUM TYPE BALL BEARINGS	Table 9.2 (Page A84)
	Table 9.4 (Page A85)
MAGNETO BEARINGS	Table 9.2 (Page A84)
	Table 9.4 (Page A85)

INTERNAL CLEARANCES

SINGLE-ROW DEEP GROOVE BALL BEARINGS	Table 9.9 (Page A89)
MAXIMUM TYPE BALL BEARINGS	Table 9.9 (Page A89)
MAGNETO BEARINGS	Table 9.11 (Page A89)

LIMITING SPEEDS

The limiting speeds listed in the bearing tables should be adjusted depending on the bearing load conditions. Also, higher speeds are attainable by making changes in the lubrication method, cage design, etc. Refer to Page A37 for detailed information.

Bore Diameter 170 – 240 mm

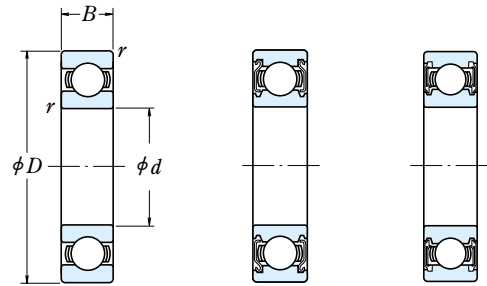

Open Type

Shielded Type
ZZS

Non-Contact
Sealed Type
VV

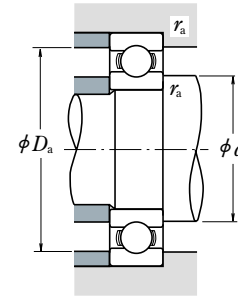

Dynamic Equivalent Load

$$P = XF_r + YF_a$$

$\frac{f_0 F_a}{C_{0r}}$	e	$\frac{F_a}{F_r} \leq e$		$\frac{F_a}{F_r} > e$	
		X	Y	X	Y
0.172	0.19	1	0	0.56	2.30
0.345	0.22	1	0	0.56	1.99
0.689	0.26	1	0	0.56	1.71
1.03	0.28	1	0	0.56	1.55
1.38	0.30	1	0	0.56	1.45
2.07	0.34	1	0	0.56	1.31
3.45	0.38	1	0	0.56	1.15
5.17	0.42	1	0	0.56	1.04
6.89	0.44	1	0	0.56	1.00

Static Equivalent Load

$$\frac{F_a}{F_r} > 0.8, P_0 = 0.6F_r + 0.5F_a$$

$$\frac{F_a}{F_r} \leq 0.8, P_0 = F_r$$

Boundary Dimensions (mm)	Basic Load Ratings (N) {kgf}				Factor f_0	Limiting Speeds (min ⁻¹)			Bearing Numbers						
	d	D	B	r min.		Grease		Oil	Open	Shielded	Sealed				
						Open Z · ZZ V · VV	DU DDU	Open Z							
170	215	22	1.1	60 000	75 000	6 100	7 650	17.1	2 600	1 600	3 000	6834	ZZS	VV	DDU
	230	28	2	86 000	97 000	8 750	9 850	16.7	2 400	—	2 800	6934	ZZS	—	—
	260	28	1.5	114 000	126 000	11 700	12 900	16.5	2 200	—	2 600	16034	—	—	—
	260	42	2.1	161 000	161 000	16 400	16 400	15.8	2 200	—	2 600	6034	ZZS	VV	—
	310	52	4	212 000	224 000	21 700	22 800	15.3	1 800	—	2 200	6234	ZZS	—	—
	360	72	4	325 000	355 000	33 500	36 000	13.6	1 600	—	2 000	6334	—	—	—
180	225	22	1.1	60 500	78 500	6 200	8 000	17.2	2 400	—	2 800	6836	—	VV	—
	250	33	2	119 000	128 000	12 100	13 100	16.4	2 200	—	2 600	6936	ZZS	—	—
	280	31	2	145 000	157 000	14 700	16 000	16.3	2 000	—	2 400	16036	—	—	—
	280	46	2.1	180 000	185 000	18 400	18 800	15.6	2 000	—	2 400	6036	ZZS	VV	—
	320	52	4	227 000	241 000	23 200	24 600	15.1	1 700	—	2 000	6236	ZZS	—	—
	380	75	4	355 000	405 000	36 000	41 500	13.9	1 500	—	1 800	6336	—	—	—
190	240	24	1.5	73 000	93 500	7 450	9 550	17.1	2 200	—	2 600	6838	—	VV	—
	260	33	2	113 000	127 000	11 500	13 000	16.6	2 200	—	2 600	6938	—	—	—
	290	31	2	149 000	168 000	15 200	17 100	16.4	2 000	—	2 400	16038	—	—	—
	290	46	2.1	188 000	201 000	19 200	20 500	15.8	2 000	—	2 400	6038	ZZS	—	—
	340	55	4	255 000	282 000	26 000	28 700	15.0	1 600	—	2 000	6238	ZZS	—	—
	400	78	5	355 000	415 000	36 000	42 500	14.1	1 400	—	1 700	6338	—	—	—
200	250	24	1.5	74 000	98 000	7 550	10 000	17.2	2 200	—	2 600	6840	—	—	—
	280	38	2.1	143 000	158 000	14 600	16 100	16.4	2 000	—	2 400	6940	ZZS	—	—
	310	34	2	161 000	180 000	16 400	18 300	16.4	1 900	—	2 200	16040	—	—	—
	310	51	2.1	207 000	226 000	21 100	23 000	15.6	1 900	—	2 200	6040	ZZS	—	—
	360	58	4	269 000	310 000	27 400	31 500	15.2	1 500	—	1 800	6240	ZZS	—	—
	420	80	5	380 000	445 000	38 500	45 500	13.8	1 300	—	1 600	6340	—	—	—
220	270	24	1.5	76 500	107 000	7 800	10 900	17.4	1 900	—	2 400	6844	ZZS	—	—
	300	38	2.1	146 000	169 000	14 900	17 300	16.6	1 800	—	2 200	6944	ZZS	—	—
	340	37	2.1	180 000	217 000	18 400	22 100	16.5	1 600	—	2 000	16044	—	—	—
	340	56	3	235 000	271 000	24 000	27 600	15.6	1 700	—	2 000	6044	ZZS	—	—
	400	65	4	310 000	375 000	31 500	38 500	15.1	1 300	—	1 600	6244	—	—	—
	460	88	5	410 000	520 000	42 000	53 000	14.3	1 200	—	1 500	6344	—	—	—
240	300	28	2	98 500	137 000	10 000	14 000	17.3	1 700	—	2 000	6848	—	—	—
	320	38	2.1	154 000	190 000	15 700	19 400	16.8	1 700	—	2 000	6948	ZZS	—	—
	360	37	2.1	196 000	243 000	19 900	24 700	16.5	1 500	—	1 900	16048	—	—	—
	360	56	3	244 000	296 000	24 900	30 000	15.9	1 500	—	1 900	6048	—	—	—
	440	72	4	340 000	430 000	34 500	44 000	15.2	1 200	—	1 500	6248	—	—	—
	500	95	5	470 000	625 000	48 000	63 500	14.2	1 100	—	1 300	6348	—	—	—

Abutment and Fillet Dimensions (mm)				Mass (kg)
$d_a^{(1)}$		$D_a^{(1)}$	r_a	
min.	max.	max.	max.	approx.
176.5	182	208.5	1	1.86
179	186	221	2	3.34
178	—	252	1.5	5.71
181	194.5	249	2	6.89
186	215	294	3	15.8
186	—	344	3	36.6
186.5	192	218.5	1	1.98
189	198.5	241	2	4.16
189	—	271	2	7.5
191	208	269	2	8.88
196	223	304	3	15.9
196	—	364	3	43.1
198	202.5	232	1.5	2.53
199	—	251	2	5.18
199	—	281	2	7.78
201	218	279	2	9.39
206	236	324	3	22.3
210	—	380	4	49.7
208	—	242	1.5	2.67
211	222	269	2	7.28
209	—	301	2	10
211	231.5	299	2	12
216	252	344	3	26.7
220	—	400	4	55.3
228	233.5	262	1.5	2.9
231	242	289	2	7.88
231	—	329	2	13.1
233	254.5	327	2.5	18.6
236	—	384	3	37.4
240	—	440	4	73.9
249	—	291	2	4.48
251	262	309	2	8.49
251	—	349	2	13.9
253	—	347	2.5	19.9
256	—	424	3	50.5
260	—	480	4	94.4

Note (1) When heavy axial loads are applied, increase d_a and decrease D_a from the above values.

Remarks When using bearings with rotating outer rings, contact NSK if they are sealed or shielded.

Bore Diameter 260 – 360 mm

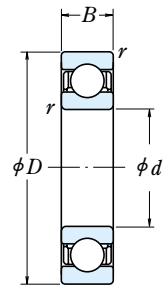

Open Type

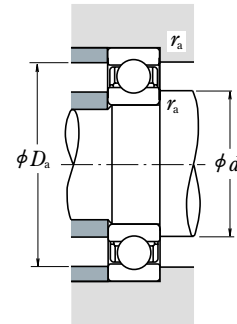

Dynamic Equivalent Load

$$P = XF_r + YF_a$$

$\frac{f_0 F_a}{C_{0r}}$	e	$\frac{F_a}{F_r} \leq e$		$\frac{F_a}{F_r} > e$	
		X	Y	X	Y
0.172	0.19	1	0	0.56	2.30
0.345	0.22	1	0	0.56	1.99
0.689	0.26	1	0	0.56	1.71
1.03	0.28	1	0	0.56	1.55
1.38	0.30	1	0	0.56	1.45
2.07	0.34	1	0	0.56	1.31
3.45	0.38	1	0	0.56	1.15
5.17	0.42	1	0	0.56	1.04
6.89	0.44	1	0	0.56	1.00

Static Equivalent Load

$$\frac{F_a}{F_r} > 0.8, P_0 = 0.6F_r + 0.5F_a$$

$$\frac{F_a}{F_r} \leq 0.8, P_0 = F_r$$

Boundary Dimensions (mm)				Basic Load Ratings				Factor	Limiting Speeds		Bearing Numbers	
d	D	B	$r_{min.}$	C_r (N)	C_{0r} (N)	C_r (kgf)	C_{0r} (kgf)		f_0	Grease		Oil
260	320	28	2	101 000	148 000	10 300	15 100	17.4	1 600	1 900	6852	
	360	46	2.1	204 000	255 000	20 800	26 000	16.5	1 500	1 800	6952	
	400	44	3	237 000	310 000	24 100	31 500	16.4	1 400	1 700	16052	
280	400	65	4	291 000	375 000	29 700	38 500	15.8	1 400	1 700	6052	
	480	80	5	400 000	540 000	41 000	55 000	15.1	1 100	1 300	6252	
	540	102	6	505 000	710 000	51 500	72 500	14.6	1 000	1 200	6352	
300	350	33	2	133 000	191 000	13 600	19 500	17.3	1 500	1 700	6856	
	380	46	2.1	209 000	272 000	21 300	27 700	16.6	1 400	1 700	6956	
	420	44	3	243 000	330 000	24 700	33 500	16.5	1 300	1 600	16056	
320	420	65	4	300 000	410 000	31 000	41 500	16.0	1 300	1 600	6056	
	500	80	5	400 000	550 000	41 000	56 000	15.2	1 000	1 300	6256	
	580	108	6	570 000	840 000	58 000	86 000	14.5	900	1 100	6356	
340	380	38	2.1	166 000	233 000	17 000	23 800	17.1	1 300	1 600	6860	
	420	56	3	269 000	370 000	27 400	38 000	16.4	1 300	1 500	6960	
	460	50	4	285 000	405 000	29 000	41 000	16.4	1 200	1 400	16060	
360	460	74	4	355 000	500 000	36 500	51 000	15.8	1 200	1 400	6060	
	540	85	5	465 000	670 000	47 500	68 500	15.1	950	1 200	6260	
	380	400	38	2.1	168 000	244 000	17 200	24 900	17.2	1 300	1 500	6864
440		56	3	266 000	375 000	27 100	38 000	16.5	1 200	1 400	6964	
480		50	4	293 000	430 000	29 800	44 000	16.5	1 100	1 300	16064	
400	480	74	4	390 000	570 000	40 000	58 000	15.7	1 100	1 300	6064	
	580	92	5	530 000	805 000	54 500	82 500	15.0	850	1 100	6264	
	420	420	38	2.1	175 000	265 000	17 800	27 100	17.3	1 200	1 400	6868
460		56	3	273 000	400 000	27 800	40 500	16.6	1 100	1 300	6968	
520		82	5	440 000	660 000	45 000	67 500	15.6	1 000	1 200	6068	
440	620	92	6	530 000	820 000	54 000	83 500	15.3	800	1 000	6268	
	460	440	38	2.1	192 000	290 000	19 600	29 600	17.3	1 100	1 300	6872
		480	56	3	280 000	425 000	28 500	43 000	16.7	1 100	1 300	6972
540		82	5	460 000	720 000	47 000	73 500	15.7	950	1 200	6072	
480	650	95	6	555 000	905 000	57 000	92 000	15.4	750	950	6272	

Note (1) When heavy axial loads are applied, increase d_a and decrease D_a from the above values.

Abutment and Fillet Dimensions (mm)			Mass (kg)
$d_a^{(1)}$ min.	$D_a^{(1)}$ max.	r_a max.	
269	311	2	4.84
271	349	2	14
273	387	2.5	21.1
276	384	3	29.4
280	460	4	67
286	514	5	118
289	341	2	7.2
291	369	2	15.1
293	407	2.5	22.7
296	404	3	31.2
300	480	4	70.4
306	554	5	144
311	369	2	10.3
313	407	2.5	23.9
316	444	3	31.5
316	444	3	44.2
320	520	4	87.8
331	389	2	10.8
333	427	2.5	25.3
336	464	3	33.2
336	464	3	46.5
340	560	4	111
351	409	2	11.5
353	447	2.5	26.6
360	500	4	62.3
366	594	5	129
371	429	2	11.8
373	467	2.5	27.9
380	520	4	65.3
386	624	5	145

Bore Diameter 380 – 600 mm

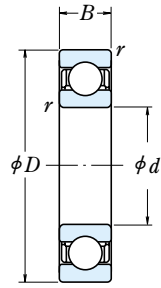

Open Type

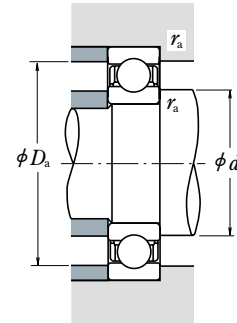

Dynamic Equivalent Load

$$P = XF_r + YF_a$$

$\frac{f_0 F_a}{C_{0r}}$	e	$\frac{F_a}{F_r} \leq e$		$\frac{F_a}{F_r} > e$	
		X	Y	X	Y
0.172	0.19	1	0	0.56	2.30
0.345	0.22	1	0	0.56	1.99
0.689	0.26	1	0	0.56	1.71
1.03	0.28	1	0	0.56	1.55
1.38	0.30	1	0	0.56	1.45
2.07	0.34	1	0	0.56	1.31
3.45	0.38	1	0	0.56	1.15
5.17	0.42	1	0	0.56	1.04
6.89	0.44	1	0	0.56	1.00

Static Equivalent Load

$$\frac{F_a}{F_r} > 0.8, P_0 = 0.6F_r + 0.5F_a$$

$$\frac{F_a}{F_r} \leq 0.8, P_0 = F_r$$

Boundary Dimensions (mm)				Basic Load Ratings				Factor	Limiting Speeds		Bearing Numbers
d	D	B	$r_{min.}$	C_r (N)	C_{0r} (N)	C_r (kgf)	C_{0r} (kgf)		f_0	Grease	
380	480	46	2.1	238 000	375 000	24 200	38 000	17.1	1 000	1 200	6876
	520	65	4	325 000	510 000	33 000	52 000	16.6	950	1 200	6976
	560	82	5	455 000	725 000	46 500	74 000	15.9	900	1 100	6076
400	500	46	2.1	241 000	390 000	24 600	40 000	17.2	950	1 200	6880
	540	65	4	335 000	540 000	34 000	55 000	16.7	900	1 100	6980
	600	90	5	510 000	825 000	52 000	84 000	15.7	850	1 000	6080
420	520	46	2.1	245 000	410 000	25 000	41 500	17.3	900	1 100	6884
	560	65	4	340 000	570 000	35 000	58 500	16.8	900	1 100	6984
	620	90	5	530 000	895 000	54 000	91 000	15.8	800	1 000	6084
440	540	46	2.1	248 000	425 000	25 300	43 500	17.4	900	1 100	6888
	600	74	4	395 000	680 000	40 500	69 000	16.6	800	1 000	6988
	650	94	6	550 000	965 000	56 000	98 500	16.0	750	900	6088
460	580	56	3	310 000	550 000	31 500	56 000	17.1	800	1 000	6892
	620	74	4	405 000	720 000	41 500	73 500	16.7	800	950	6992
	680	100	6	605 000	1 080 000	62 000	110 000	15.8	710	850	6092
480	600	56	3	315 000	575 000	32 000	58 500	17.2	800	950	6896
	650	78	5	450 000	815 000	45 500	83 000	16.6	750	900	6996
	700	100	6	605 000	1 090 000	61 500	111 000	15.9	710	850	6096
500	620	56	3	320 000	600 000	33 000	61 000	17.3	750	900	68/500
	670	78	5	460 000	865 000	47 000	88 000	16.7	710	850	69/500
	720	100	6	630 000	1 170 000	64 000	120 000	16.0	670	800	60/500
530	650	56	3	325 000	625 000	33 000	63 500	17.4	710	850	68/530
	710	82	5	455 000	870 000	46 500	88 500	16.8	670	800	69/530
	780	112	6	680 000	1 300 000	69 500	133 000	16.0	600	750	60/530
560	680	56	3	330 000	650 000	33 500	66 500	17.4	670	800	68/560
	750	85	5	525 000	1 040 000	53 500	106 000	16.7	600	750	69/560
	820	115	6	735 000	1 500 000	75 000	153 000	16.2	560	670	60/560
600	730	60	3	355 000	735 000	36 000	75 000	17.5	600	710	68/600
	800	90	5	550 000	1 160 000	56 500	118 000	16.9	560	670	69/600
	870	118	6	790 000	1 640 000	80 500	168 000	16.1	530	630	60/600

Abutment and Fillet Dimensions (mm)			Mass (kg)
$d_a^{(1)}$ min.	$D_a^{(1)}$ max.	r_a max.	
391	469	2	19.5
396	504	3	40
400	540	4	68
411	489	2	20.5
416	524	3	42
420	580	4	88.4
431	509	2	21.4
436	544	3	43.6
440	600	4	92.2
451	529	2	22.3
456	584	3	60.2
466	624	5	106
473	567	2.5	34.3
476	604	3	62.6
486	654	5	123
493	587	2.5	35.4
500	630	4	73.5
506	674	5	127
513	607	2.5	37.2
520	650	4	82
526	694	5	131
543	637	2.5	39.8
550	690	4	89.8
556	754	5	184
573	667	2.5	41.5
580	730	4	105
586	793.5	5	203
613	717	2.5	50.9
620	780	4	120
626	844	5	236

Note (1) When heavy axial loads are applied, increase d_a and decrease D_a from the above values.

SINGLE-ROW DEEP GROOVE BALL BEARINGS

Bore Diameter 630 – 800 mm

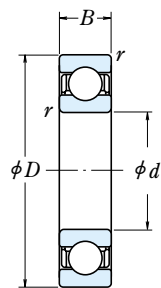

Open Type

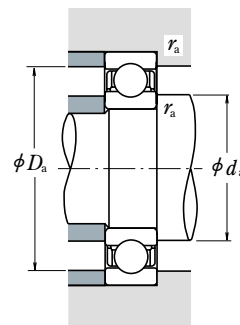

Dynamic Equivalent Load

$$P = XF_r + YF_a$$

$\frac{f_0 F_a}{C_{0r}}$	e	$\frac{F_a}{F_r} \leq e$		$\frac{F_a}{F_r} > e$	
		X	Y	X	Y
0.172	0.19	1	0	0.56	2.30
0.345	0.22	1	0	0.56	1.99
0.689	0.26	1	0	0.56	1.71
1.03	0.28	1	0	0.56	1.55
1.38	0.30	1	0	0.56	1.45
2.07	0.34	1	0	0.56	1.31
3.45	0.38	1	0	0.56	1.15
5.17	0.42	1	0	0.56	1.04
6.89	0.44	1	0	0.56	1.00

Static Equivalent Load

$$\frac{F_a}{F_r} > 0.8, P_0 = 0.6F_r + 0.5F_a$$

$$\frac{F_a}{F_r} \leq 0.8, P_0 = F_r$$

Boundary Dimensions (mm)				Basic Load Ratings				Factor	Limiting Speeds		Bearing Numbers
d	D	B	r min.	(N)		{kgf}			f_0	Grease	
630	780	69	4	420 000	890 000	43 000	90 500	17.3			560
	850	100	6	625 000	1 350 000	64 000	138 000	16.7	530	630	69/630
	920	128	7.5	750 000	1 620 000	76 500	165 000	16.4	480	600	60/630
670	820	69	4	435 000	965 000	44 500	98 000	17.4	500	630	68/670
	900	103	6	675 000	1 460 000	68 500	149 000	16.7	480	560	69/670
	980	136	7.5	765 000	1 730 000	78 000	177 000	16.6	450	530	60/670
710	870	74	4	480 000	1 100 000	49 000	113 000	17.4	480	560	68/710
	950	106	6	715 000	1 640 000	72 500	167 000	16.8	450	530	69/710
750	920	78	5	525 000	1 260 000	53 500	128 000	17.4	430	530	68/750
	1 000	112	6	785 000	1 840 000	80 000	188 000	16.7	400	500	69/750
800	980	82	5	530 000	1 310 000	54 000	133 000	17.5	400	480	68/800
	1 060	115	6	825 000	2 050 000	84 500	209 000	16.8	380	450	69/800

Note (1) When heavy axial loads are applied, increase d_a and decrease D_a from the above values.

Abutment and Fillet Dimensions (mm)			Mass (kg)
$d_a^{(1)}$ min.	$D_a^{(1)}$ max.	r_a max.	
646	764	3	71.3
656	824	5	163
662	888	6	285
686	804	3	75.4
696	874	5	181
702	948	6	351
726	854	3	92.6
736	924	5	208
770	900	4	110
776	974	5	245
820	960	4	132
826	1 034	5	275

Bore Diameter 25 – 110 mm

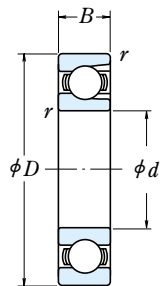

Open Type



Shielded Type
(One Shield) Z

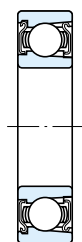

Shielded Type
(Two Shields) ZZ

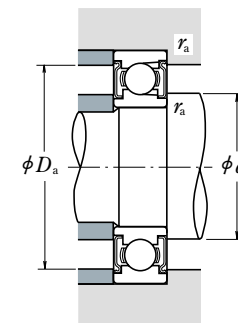
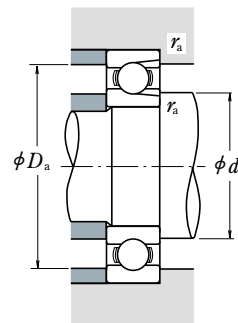

Boundary Dimensions (mm)				Basic Load Ratings				Limiting Speeds		Open
<i>d</i>	<i>D</i>	<i>B</i>	<i>r</i> min.	<i>C_r</i> (N)	<i>C_{0r}</i> {kgf}	<i>C_r</i>	<i>C_{0r}</i>	Grease Open Z · ZZ	Oil Open Z	
25	52	15	1	14 400	10 500	1 470	1 070	12 000	15 000	BL 205 BL 305
	62	17	1.1	21 500	15 500	2 200	1 580	11 000	13 000	
30	62	16	1	21 000	16 300	2 150	1 660	10 000	12 000	BL 206 BL 306
	72	19	1.1	27 900	20 700	2 840	2 110	9 000	11 000	
35	72	17	1.1	27 800	22 100	2 830	2 250	9 000	11 000	BL 207 BL 307
	80	21	1.5	37 000	29 100	3 800	2 970	8 000	9 500	
40	80	18	1.1	35 500	28 800	3 600	2 940	8 000	9 500	BL 208 BL 308
	90	23	1.5	46 500	36 000	4 750	3 650	7 500	9 000	
45	85	19	1.1	37 000	32 000	3 800	3 250	7 500	9 000	BL 209 BL 309
	100	25	1.5	55 500	44 000	5 650	4 500	6 300	8 000	
50	90	20	1.1	39 000	35 000	3 950	3 550	6 700	8 500	BL 210 BL 310
	110	27	2	65 000	52 500	6 600	5 350	6 000	7 100	
55	100	21	1.5	48 000	44 000	4 900	4 500	6 300	7 500	BL 211 BL 311
	120	29	2	75 000	61 500	7 650	6 250	5 600	6 700	
60	110	22	1.5	58 000	54 000	5 950	5 550	5 600	6 700	BL 212 BL 312
	130	31	2.1	85 500	71 500	8 700	7 300	5 000	6 000	
65	120	23	1.5	63 500	60 000	6 450	6 150	5 300	6 300	BL 213 BL 313
	140	33	2.1	103 000	89 500	10 500	9 150	4 800	5 600	
70	125	24	1.5	69 000	66 000	7 050	6 750	5 000	6 000	BL 214 BL 314
	150	35	2.1	115 000	102 000	11 800	10 400	4 300	5 300	
75	130	25	1.5	72 000	72 000	7 350	7 300	4 500	5 600	BL 215 BL 315
	160	37	2.1	126 000	116 000	12 800	11 800	4 000	5 000	
80	140	26	2	84 000	85 000	8 600	8 650	4 300	5 300	BL 216 BL 316
	170	39	2.1	136 000	130 000	13 900	13 300	3 800	4 500	
85	150	28	2	93 000	93 000	9 500	9 450	4 000	5 000	BL 217 BL 317
	180	41	3	147 000	145 000	15 000	14 800	3 600	4 300	
90	160	30	2	107 000	107 000	10 900	10 900	3 800	4 500	BL 218 BL 318
	190	43	3	158 000	161 000	16 100	16 400	3 400	4 000	
95	170	32	2.1	121 000	123 000	12 300	12 500	3 600	4 300	BL 219 BL 319
	200	45	3	169 000	178 000	17 300	18 100	2 800	3 600	
100	180	34	2.1	136 000	140 000	13 800	14 200	3 400	4 000	BL 220
105	190	36	2.1	148 000	157 000	15 000	16 000	3 200	3 800	BL 221
110	200	38	2.1	160 000	176 000	16 300	17 900	2 800	3 400	BL 222

Remarks When using Maximum Type Ball Bearings, please contact NSK.

Bearing Numbers		Abutment and Fillet Dimensions (mm)				Mass (kg) approx.
With One Shielded	With Two Shields	<i>d_a</i> min.	<i>d_b</i> max.	<i>D_a</i> max.	<i>r_a</i> max.	
BL 205 Z	BL 205 ZZ	30	32	47	1	0.133
BL 305 Z	BL 305 ZZ	31.5	36	55.5	1	0.246
BL 206 Z	BL 206 ZZ	35	38.5	57	1	0.215
BL 306 Z	BL 306 ZZ	36.5	42	65.5	1	0.364
BL 207 Z	BL 207 ZZ	41.5	44.5	65.5	1	0.307
BL 307 Z	BL 307 ZZ	43	44.5	72	1.5	0.486
BL 208 Z	BL 208 ZZ	46.5	50	73.5	1	0.394
BL 308 Z	BL 308 ZZ	48	52.5	82	1.5	0.685
BL 209 Z	BL 209 ZZ	51.5	55.5	78.5	1	0.449
BL 309 Z	BL 309 ZZ	53	61.5	92	1.5	0.883
BL 210 Z	BL 210 ZZ	56.5	60	83.5	1	0.504
BL 310 Z	BL 310 ZZ	59	68	101	2	1.16
BL 211 Z	BL 211 ZZ	63	66.5	92	1.5	0.667
BL 311 Z	BL 311 ZZ	64	72.5	111	2	1.49
BL 212 Z	BL 212 ZZ	68	74.5	102	1.5	0.856
BL 312 Z	BL 312 ZZ	71	79	119	2	1.88
BL 213 Z	BL 213 ZZ	73	80	112	1.5	1.09
BL 313 Z	BL 313 ZZ	76	85.5	129	2	2.36
BL 214 Z	BL 214 ZZ	78	84	117	1.5	1.19
BL 314 Z	BL 314 ZZ	81	92	139	2	2.87
BL 215 Z	BL 215 ZZ	83	90	122	1.5	1.29
BL 315 Z	BL 315 ZZ	86	98.5	149	2	3.43
BL 216 Z	BL 216 ZZ	89	95.5	131	2	1.61
BL 316 Z	BL 316 ZZ	91	104.5	159	2	4.08
BL 217 Z	BL 217 ZZ	94	102	141	2	1.97
BL 317 Z	BL 317 ZZ	98	110.5	167	2.5	4.77
BL 218 Z	BL 218 ZZ	99	107.5	151	2	2.43
BL 318 Z	BL 318 ZZ	103	117	177	2.5	5.45
BL 219 Z	BL 219 ZZ	106	114	159	2	2.95
BL 319 Z	BL 319 ZZ	108	124	187	2.5	6.4
BL 220 Z	BL 220 ZZ	111	121.5	169	2	3.54
BL 221 Z	BL 221 ZZ	116	127.5	179	2	4.23
—	—	121	—	189	2	4.84

Bore Diameter 4 – 20 mm

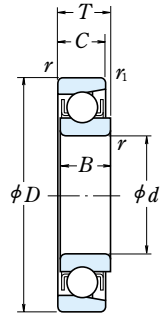

Outside Diameter Tolerance (Class N)

Units : μm

Nominal Outside Diameter D (mm)		Single Plane Mean Outside Diameter ΔD_{mp}			
		E Series		EN Series	
Over	Incl	High	Low	High	Low
—	10	+ 8	0	0	- 8
10	18	+ 8	0	0	- 8
18	30	+ 9	0	0	- 9
30	50	+11	0	0	-11

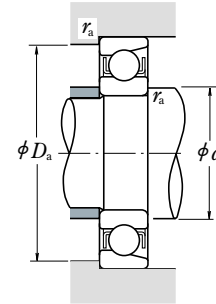

Dynamic Equivalent Load

$$P = XF_r + YF_a$$

$F_a/F_r \leq e$		$F_a/F_r > e$		e
X	Y	X	Y	
1	0	0.5	2.5	0.2

Boundary Dimensions (mm)					Basic Load Ratings (N) (kgf)				Limiting Speeds (min ⁻¹)		Bearing Numbers	
d	D	B, C, T	r min.	r_1 min.	C_r	C_{0r}	C_r	C_{0r}	Grease	Oil	E Series	EN Series
4	16	5	0.15	0.1	1 650	288	168	29	34 000	40 000	E 4	EN 4
5	16	5	0.15	0.1	1 650	288	168	29	34 000	40 000	E 5	EN 5
6	21	7	0.3	0.15	2 490	445	254	46	30 000	36 000	E 6	EN 6
7	22	7	0.3	0.15	2 490	445	254	46	30 000	36 000	E 7	EN 7
8	24	7	0.3	0.15	3 450	650	350	66	28 000	34 000	E 8	EN 8
9	28	8	0.3	0.15	4 550	880	465	90	24 000	30 000	E 9	EN 9
10	28	8	0.3	0.15	4 550	880	465	90	24 000	30 000	E 10	EN 10
11	32	7	0.3	0.15	4 400	845	450	86	22 000	26 000	E 11	EN 11
12	32	7	0.3	0.15	4 400	845	450	86	22 000	26 000	E 12	EN 12
13	30	7	0.3	0.15	4 400	845	450	86	22 000	26 000	E 13	EN 13
14	35	8	0.3	0.15	5 800	1 150	590	117	19 000	22 000	—	EN 14
15	35	8	0.3	0.15	5 800	1 150	590	117	19 000	22 000	E 15	EN 15
	40	10	0.6	0.3	7 400	1 500	750	153	17 000	20 000	BO 15	—
16	38	10	0.6	0.2	6 900	1 380	705	141	17 000	22 000	—	EN 16
17	40	10	0.6	0.3	7 400	1 500	750	153	17 000	20 000	L 17	—
	44	11	0.6	0.3	7 350	1 500	750	153	16 000	19 000	—	EN 17
	44	11	0.6	0.3	7 350	1 500	750	153	16 000	19 000	BO 17	—
18	40	9	0.6	0.2	5 050	1 030	515	105	17 000	20 000	—	EN 18
19	40	9	0.6	0.2	5 050	1 030	515	105	17 000	20 000	E 19	EN 19
20	47	12	1	0.6	11 000	2 380	1 120	243	14 000	17 000	E 20	EN 20
	47	14	1	0.6	11 000	2 380	1 120	243	14 000	17 000	L 20	—

Abutment and Fillet Dimensions (mm)			Mass (kg) approx.
d_a min.	D_a max.	r_a max.	
5.2	14.8	0.15	0.005
6.2	14.8	0.15	0.004
8	19	0.3	0.011
9	20	0.3	0.013
10	22	0.3	0.014
11	26	0.3	0.022
12	26	0.3	0.021
13	30	0.3	0.029
14	30	0.3	0.028
15	28	0.3	0.021
16	33	0.3	0.035
17	33	0.3	0.034
19	36	0.6	0.055
20	34	0.6	0.049
21	36	0.6	0.051
21	40	0.6	0.080
21	40	0.6	0.080
22	36	0.6	0.051
23	36	0.6	0.049
25	42	1	0.089
25	42	1	0.101

- Remarks**
1. The outside diameters of Magneto Bearings Series E always have plus tolerances.
 2. When using Magneto Bearings other than E, please contact NSK.

EXTRA SMALL BALL BEARINGS AND MINIATURE BALL BEARINGS

EXTRA SMALL BALL BEARINGS · MINIATURE BALL BEARINGS

Metric Design	Bore Diameter 1 – 9mm	B34
	With Flange	B38
Inch Design	Bore Diameter 1.016 – 9.525mm	B42
	With Flange	B44

DESIGN AND TYPES

The size ranges of extra small and miniature ball bearings are shown in Table 1. The design, types, and type symbols are shown in Table 2. Those types among them that are listed in the bearing tables are indicated by the shading in Table 2.

Table 1 Size Ranges of Bearings

Units : mm

Design	Extra Small Ball Bearings	Miniature Ball Bearings
Metric	Outside diameter $D \geq 9$ Bore diameter $d < 10$	Outside diameter $D < 9$
Inch	Outside diameter $D \geq 9.525$ Bore diameter $d < 10$	Outside diameter $D < 9.525$

Please refer to NSK Miniature Ball Bearings (CAT. No. E126) for details.

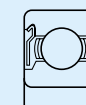
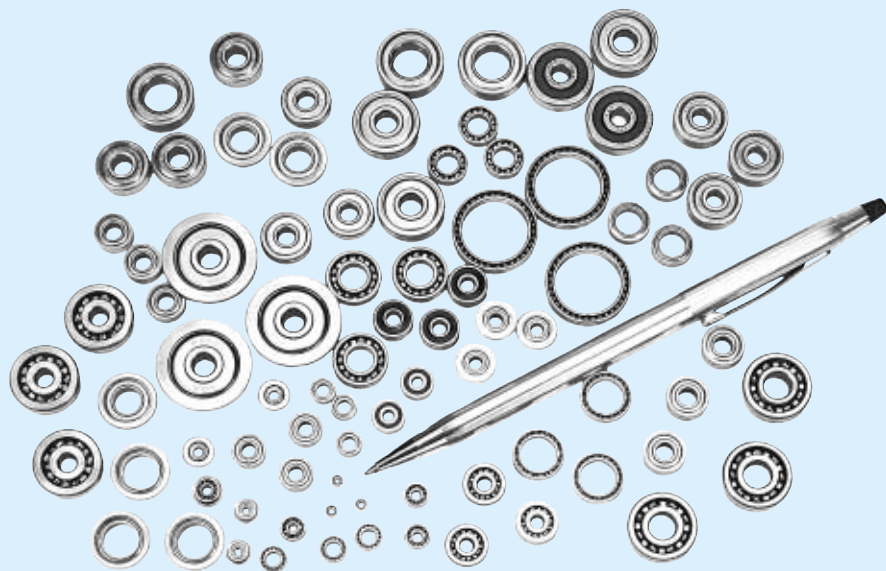

ZZ

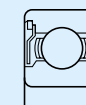

ZZS

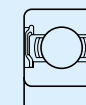



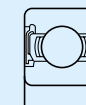





DD



VV

Table 2 Design, Types, and Type Symbols

Design · Types	Type Symbols				Remarks
	Metric	Inch	Special		
			Metric	Inch	
	6 0 0	R	MR	—	Shielded · sealed bearings are available.
 Thin section	—	—	SMT	—	
 With flange	F6 0 0	FR	MF	—	Shielded · sealed bearings are available.
 Extended inner ring	—	—	—	RW	Shielded bearings are available.
 With flange and extended inner ring	—	—	—	FRW	Shielded bearings are available.
 For synchro motors	—	—	—	SR00X00	Shielded bearings are available.
 Pivot Ball Bearings	—	—	BCF	—	
 Thrust Ball Bearings	—	—	F	—	

Remarks Single-row angular contact ball bearings are available besides those shown above.

TOLERANCES AND RUNNING ACCURACY

METRIC DESIGN BEARINGSTable 8.2(Pages A60 to A63)

The flange tolerances for metric design bearings are listed in Table 3.

Table 3 Flange Tolerances for Metric Flanged Bearings

(1) Tolerances of Flange Outside Diameter Units : μm

Nominal Flange Outside Diameter		Deviation of Flange Outside Diameter			
D_1 (mm)		ΔD_{1S}			
		①		②	
over	incl.	high	low	high	low
10	18	+220	-36	0	-36
10	18	+270	-43	0	-43
18	30	+330	-52	0	-52

Remarks ② is applied when the flange outside diameter is used for positioning.

(2) Flange Width Tolerances and Running Accuracies Related to Flange Units : μm

Nominal Bearing Outside Diameter D (mm)	Deviation of Flange Width ΔC_{1S}	Variation of Flange Width ΔC_{1S}			Variation of Bearing Outside Surface Generatrix Inclination with Flange Backface S_{D1}			Flange Backface Runout with Raceway S_{ea1}					
		V_{C1S}			Class 5			Class 4					
		Normal and Classes 6,5,4,2	Normal and class 6	Class 5	Class 4	Class 2	Class 5	Class 4	Class 2	Class 5	Class 4	Class 2	
over	incl.	high	low	max.			max.			max.			
2.5 ⁽¹⁾	6	Use the ΔB_S tolerance for d of the same bearing of the same class			5	2.5	1.5	8	4	1.5	11	7	3
6	18	Use the ΔV_{BS} tolerance for d of the same bearing of the same class			5	2.5	1.5	8	4	1.5	11	7	3
18	30	Use the ΔV_{BS} tolerance for d of the same bearing of the same class			5	2.5	1.5	8	4	1.5	11	7	3

Notes (1) 2.5mm is included

INCH DESIGN BEARINGSTable 8.2 (Pages A60 to A63)

The flange tolerances for inch design flanged bearings are listed in Table 8.8(2) (Pages A76 and A77).

INSTRUMENT BALL BEARINGSTable 8.8 (Pages A76 to A77)

RECOMMENDED FITS

Please refer to NSK Miniature Ball Bearings (CAT.No.E126).

INTERNAL CLEARANCESTable 9.10 (Page A89)

LIMITING SPEEDS

The limiting speeds listed in the bearing tables should be adjusted depending on the bearing load conditions. Also, higher speeds are attainable by making changes in the lubrication method, cage design, etc. Refer to Page A37 for detailed information.

Metric Design

Bore Diameter 1 – 4 mm

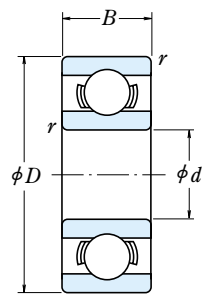

Open Type

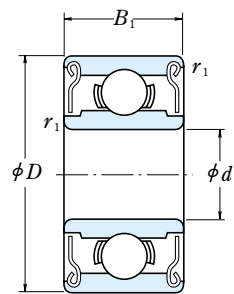

Shielded Type
ZZ · ZZ1

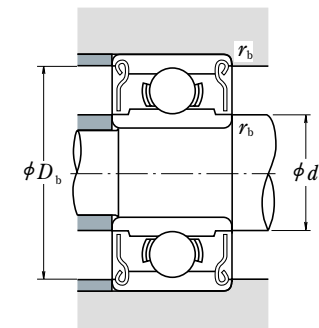
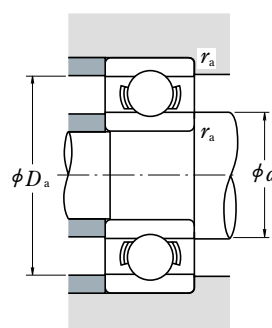

d	Boundary Dimensions (mm)					Basic Load Ratings (N)				Limiting Speeds (min ⁻¹)		Open
	D	B	B ₁	r ⁽¹⁾ min.	r ₁ ⁽¹⁾ min.	C _r	C _{0r}	C _r	C _{0r}	Grease Open Z · ZZ	Oil Open Z	
1	3	1	—	0.05	—	80	23	8	2.5	130 000	150 000	681
	3	1.5	—	0.05	—	80	23	8	2.5	130 000	150 000	MR 31
	4	1.6	—	0.1	—	138	35	14	3.5	100 000	120 000	691
1.2	4	1.8	2.5	0.1	0.1	138	35	14	3.5	110 000	130 000	MR 41 X
1.5	4	1.2	2	0.05	0.05	112	33	11	3.5	100 000	120 000	681 X
	5	2	2.6	0.15	0.15	237	69	24	7	85 000	100 000	691 X
	6	2.5	3	0.15	0.15	330	98	34	10	75 000	90 000	601 X
2	5	1.5	2.3	0.08	0.08	169	50	17	5	85 000	100 000	682
	5	2	2.5	0.1	0.1	187	58	19	6	85 000	100 000	MR 52 B
	6	2.3	3	0.15	0.15	330	98	34	10	75 000	90 000	692
2.5	6	2.5	2.5	0.15	0.15	330	98	34	10	75 000	90 000	MR 62
	7	2.5	3	0.15	0.15	385	127	39	13	63 000	75 000	MR 72
	7	2.8	3.5	0.15	0.15	385	127	39	13	63 000	75 000	602
3	6	1.8	2.6	0.08	0.08	208	74	21	7.5	71 000	80 000	682 X
	7	2.5	3.5	0.15	0.15	385	127	39	13	63 000	75 000	692 X
	8	2.5	—	0.2	—	560	179	57	18	60 000	67 000	MR 82 X
4	8	2.8	4	0.15	0.15	550	175	56	18	60 000	71 000	602 X
	6	2	2.5	0.1	0.1	208	74	21	7.5	71 000	80 000	MR 63
	7	2	3	0.1	0.1	390	130	40	13	63 000	75 000	683 A
4	8	2.5	—	0.15	—	560	179	57	18	60 000	67 000	MR 83
	8	3	4	0.15	0.15	560	179	57	18	60 000	67 000	693
	9	2.5	4	0.2	0.15	570	187	58	19	56 000	67 000	MR 93
4	9	3	5	0.15	0.15	570	187	58	19	56 000	67 000	603
	10	4	4	0.15	0.15	630	218	64	22	50 000	60 000	623
	13	5	5	0.2	0.2	1 300	485	133	49	40 000	48 000	633
4	7	2	—	0.1	—	310	115	32	12	60 000	67 000	MR 74
	7	—	2.5	—	0.1	255	107	26	11	60 000	71 000	—
	8	2	3	0.15	0.1	395	139	40	14	56 000	67 000	MR 84
4	9	2.5	4	(0.15)	(0.15)	640	225	65	23	53 000	63 000	684 A
	10	3	4	0.2	0.15	710	270	73	28	50 000	60 000	MR 104 B
	11	4	4	0.15	0.15	960	345	98	35	48 000	56 000	694
4	12	4	4	0.2	0.2	960	345	98	35	48 000	56 000	604
	13	5	5	0.2	0.2	1 300	485	133	49	40 000	48 000	624
	16	5	5	0.3	0.3	1 730	670	177	68	36 000	43 000	634

Note (1) The values in parentheses are not based on ISO 15.

Remarks When using bearings with a rotating outer ring, please contact NSK if they are shielded.

Bearing Numbers		Abutment and Fillet Dimensions (mm)						Mass (g)	
Shielded	Sealed	d _a min.	d _b max.	D _a max.	D _b min.	r _a max.	r _b max.	Open	approx. Shielded
—	—	1.4	—	2.6	—	0.05	—	0.03	—
—	—	1.4	—	2.6	—	0.05	—	0.04	—
—	—	1.8	—	3.2	—	0.1	—	0.09	—
MR 41 XZZ	—	2.0	1.9	3.2	3.5	0.1	0.1	0.10	0.14
681 XZZ	—	1.9	2.1	3.6	3.6	0.05	0.05	0.07	0.11
691 XZZ	—	2.7	2.5	3.8	4.3	0.15	0.15	0.17	0.20
601 XZZ	—	2.7	3.0	4.8	5.4	0.15	0.15	0.33	0.38
682 ZZ	—	2.6	2.7	4.4	4.2	0.08	0.08	0.12	0.17
MR 52 BZZ	—	2.8	2.7	4.2	4.4	0.1	0.1	0.16	0.23
692 ZZ	—	3.2	3.0	4.8	5.4	0.15	0.15	0.28	0.38
MR 62 ZZ	—	3.2	3.0	4.8	5.2	0.15	0.15	0.30	0.29
MR 72 ZZ	—	3.2	3.8	5.8	6.2	0.15	0.15	0.45	0.49
602 ZZ	—	3.2	3.8	5.8	6.2	0.15	0.15	0.51	0.58
682 XZZ	—	3.1	3.7	5.4	5.4	0.08	0.08	0.23	0.29
692 XZZ	—	3.7	3.8	5.8	6.2	0.15	0.15	0.41	0.55
—	—	4.1	—	6.4	—	0.2	—	0.56	—
602 XZZ	—	3.7	4.1	6.8	7.0	0.15	0.15	0.63	0.83
MR 63 ZZ	—	3.8	3.7	5.2	5.4	0.1	0.1	0.20	0.27
683 AZZ	—	3.8	4.0	6.2	6.4	0.1	0.1	0.32	0.45
—	—	4.2	—	6.8	—	0.15	—	0.54	—
693 ZZ	—	4.2	4.3	6.8	7.3	0.15	0.15	0.61	0.83
MR 93 ZZ	—	4.6	4.3	7.4	7.9	0.2	0.15	0.73	1.18
603 ZZ	—	4.2	4.3	7.8	7.9	0.15	0.15	0.87	1.45
623 ZZ	—	4.2	4.3	8.8	8.0	0.15	0.15	1.65	1.66
633 ZZ	—	4.6	6.0	11.4	11.3	0.2	0.2	3.38	3.33
—	—	4.8	—	6.2	—	0.1	—	0.22	—
MR 74 ZZ	—	—	4.8	—	6.3	—	0.1	—	0.29
MR 84 ZZ	—	5.2	5.0	6.8	7.4	0.15	0.1	0.36	0.56
684 AZZ	—	4.8	5.2	8.2	8.1	0.1	0.1	0.63	1.01
MR 104 BZZ	—	5.6	5.9	8.4	8.8	0.2	0.15	1.04	1.42
694 ZZ	—	5.2	5.6	9.8	9.9	0.15	0.15	1.7	1.75
604 ZZ	—	5.6	5.6	10.4	9.9	0.2	0.2	2.25	2.29
624 ZZ	—	5.6	6.0	11.4	11.3	0.2	0.2	3.03	3.04
634 ZZ1	—	6.0	7.5	14.0	13.8	0.3	0.3	5.24	5.21

Metric Design
Bore Diameter 5 – 9 mm

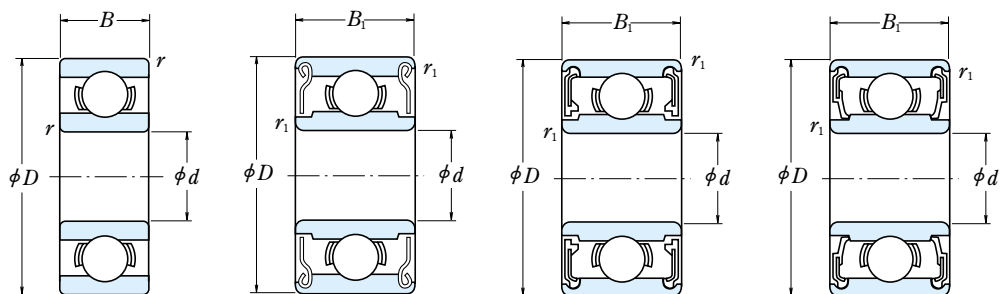

Open Type Shielded Type ZZ · ZZ1 Non-Contact Sealed Type VV Contact Sealed Type DD

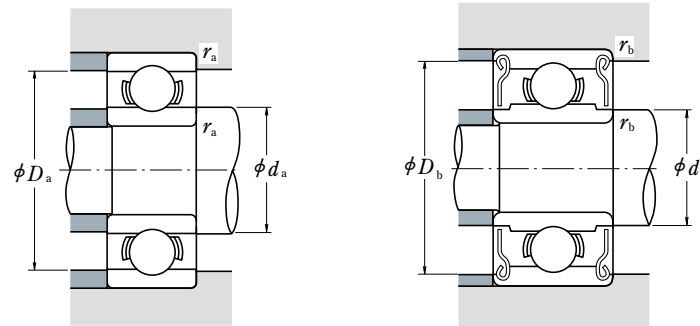

Boundary Dimensions (mm)					Basic Load Ratings (N) (kgf)				Limiting Speeds (min ⁻¹) Grease			Open	
d	D	B	B ₁	r ⁽¹⁾ min.	r ₁ ⁽¹⁾ min.	C _r	C _{0r}	C _r	C _{0r}	Open Z · ZZ V · VV	D · DD		Open Z
5	8	2	—	0.1	—	310	120	31	12	53 000	—	63 000	MR 85
	8	—	2.5	—	0.1	278	131	28	13	53 000	—	63 000	—
	9	2.5	3	0.15	0.15	430	168	44	17	50 000	—	60 000	MR 95
	10	3	4	0.15	0.15	430	168	44	17	50 000	—	60 000	MR 105
	11	—	4	—	0.15	715	276	73	28	48 000	—	56 000	—
	11	3	5	0.15	0.15	715	281	73	29	45 000	—	53 000	685
	13	4	4	0.2	0.2	1 080	430	110	44	43 000	40 000	50 000	695
	14	5	5	0.2	0.2	1 330	505	135	52	40 000	38 000	50 000	605
	16	5	5	0.3	0.3	1 730	670	177	68	36 000	32 000	43 000	625
	19	6	6	0.3	0.3	2 340	885	238	90	32 000	30 000	40 000	635
6	10	2.5	3	0.15	0.1	495	218	51	22	45 000	—	53 000	MR 106
	12	3	4	0.2	0.15	715	292	73	30	43 000	40 000	50 000	MR 126
	13	3.5	5	0.15	0.15	1 080	440	110	45	40 000	38 000	50 000	686 A
	15	5	5	0.2	0.2	1 730	670	177	68	40 000	36 000	45 000	696
	17	6	6	0.3	0.3	2 260	835	231	85	38 000	34 000	45 000	606
	19	6	6	0.3	0.3	2 340	885	238	90	32 000	30 000	40 000	626
	22	7	7	0.3	0.3	3 300	1 370	335	140	30 000	28 000	36 000	636
	7	11	2.5	3	0.15	0.1	455	201	47	21	43 000	—	50 000
13		3	4	0.2	0.15	540	276	55	28	40 000	—	48 000	MR 137
14		3.5	5	0.15	0.15	1 170	510	120	52	40 000	34 000	45 000	687
17		5	5	0.3	0.3	1 610	710	164	73	36 000	28 000	43 000	697
19		6	6	0.3	0.3	2 340	885	238	90	36 000	32 000	43 000	607
22		7	7	0.3	0.3	3 300	1 370	335	140	30 000	28 000	36 000	627
26		9	9	0.3	0.3	4 550	1 970	465	201	28 000	22 000	34 000	637
8		12	2.5	3.5	0.15	0.1	545	274	56	28	40 000	—	48 000
	14	3.5	4	0.2	0.15	820	385	83	39	38 000	32 000	45 000	MR 148
	16	4	5	0.2	0.2	1 610	710	164	73	36 000	28 000	43 000	688 A
	19	6	6	0.3	0.3	2 240	910	228	93	36 000	28 000	43 000	698
	22	7	7	0.3	0.3	3 300	1 370	335	140	34 000	28 000	40 000	608
	24	8	8	0.3	0.3	3 350	1 430	340	146	28 000	24 000	34 000	628
	28	9	9	0.3	0.3	4 550	1 970	465	201	28 000	22 000	34 000	638
	9	17	4	5	0.2	0.2	1 330	665	136	68	36 000	24 000	43 000
20		6	6	0.3	0.3	1 720	840	175	86	34 000	24 000	40 000	699
24		7	7	0.3	0.3	3 350	1 430	340	146	32 000	24 000	38 000	609
26		8	8	(0.6)	(0.6)	4 550	1 970	465	201	28 000	22 000	34 000	629
30		10	10	0.6	0.6	5 100	2 390	520	244	24 000	—	30 000	639

Note (1) The values in parentheses are not based on ISO 15.

Remarks 1. When using bearings with a rotating outer ring, please contact NSK if they are sealed or shielded.
2. Bearings with snap rings are also available, please contact NSK.

Bearing Numbers			Abutment and Fillet Dimensions (mm)						Mass (g)	
Shielded	Sealed		d _a min.	d _b max.	D _a max.	D _b min.	r _a max.	r _b max.	Open	approx. Shielded
—	—	—	5.8	—	7.2	—	0.1	—	0.26	—
MR 85 ZZ	—	—	—	5.8	—	7.4	—	0.1	—	0.34
MR 95 ZZ1	—	—	6.2	6.0	7.8	8.2	0.15	0.15	0.50	0.58
MR 105 ZZ	—	—	6.2	6.0	8.8	8.4	0.15	0.15	0.95	1.29
MR 115 ZZ	VV	—	—	6.3	—	9.8	—	0.15	—	1.49
685 ZZ	—	—	6.2	6.2	9.8	9.9	0.15	0.15	1.2	1.96
695 ZZ	VV	DD	6.6	6.6	11.4	11.2	0.2	0.2	2.45	2.5
605 ZZ	—	DD	6.6	6.9	12.4	12.2	0.2	0.2	3.54	3.48
625 ZZ1	VV	DD	7.0	7.5	14.0	13.8	0.3	0.3	4.95	4.86
635 ZZ1	VV	DD	7.0	8.5	17.0	16.5	0.3	0.3	8.56	8.34
MR 106 ZZ1	—	—	7.2	7.0	8.8	9.3	0.15	0.1	0.56	0.68
MR 126 ZZ	—	DD	7.6	7.2	10.4	10.9	0.2	0.15	1.27	1.74
686 AZZ	VV	DD	7.2	7.4	11.8	11.7	0.15	0.15	1.91	2.69
696 ZZ1	VV	DD	7.6	7.9	13.4	13.3	0.2	0.2	3.88	3.72
606 ZZ	VV	DD	8.0	8.2	15.0	14.8	0.3	0.3	5.97	6.08
626 ZZ1	VV	DD	8.0	8.5	17.0	16.5	0.3	0.3	8.15	7.94
636 ZZ	VV	DD	8.0	10.5	20.0	19.0	0.3	0.3	14	14
MR 117 ZZ	—	—	8.2	8.0	9.8	10.5	0.15	0.1	0.62	0.72
MR 137 ZZ	—	—	8.6	9.0	11.4	11.6	0.2	0.15	1.58	2.02
687 ZZ1	VV	DD	8.2	8.5	12.8	12.7	0.15	0.15	2.13	2.97
697 ZZ1	VV	DD	9.0	10.2	15.0	14.8	0.3	0.3	5.26	5.12
607 ZZ1	VV	DD	9.0	9.1	17.0	16.5	0.3	0.3	7.67	7.51
627 ZZ	VV	DD	9.0	10.5	20.0	19.0	0.3	0.3	12.7	12.9
637 ZZ1	VV	DD	9.0	12.8	24.0	22.8	0.3	0.3	24	25
MR 128 ZZ1	—	—	9.2	9.0	10.8	11.3	0.15	0.1	0.71	0.97
MR 148 ZZ	VV	DD	9.6	9.2	12.4	12.8	0.2	0.15	1.86	2.16
688 AZZ1	VV	DD	9.6	10.2	14.4	14.2	0.2	0.2	3.12	4.02
698 ZZ	VV	DD	10.0	10.0	17.0	16.5	0.3	0.3	7.23	7.18
608 ZZ	VV	DD	10.0	10.5	20.0	19.0	0.3	0.3	12.1	12.2
628 ZZ	VV	DD	10.0	12.0	22.0	20.5	0.3	0.3	17.2	17.4
638 ZZ1	VV	DD	10.0	12.8	26.0	22.8	0.3	0.3	28.3	28.6
689 ZZ1	VV	DD	10.6	11.5	15.4	15.2	0.2	0.2	3.53	4.43
699 ZZ1	VV	DD	11.0	12.0	18.0	17.2	0.3	0.3	8.45	8.33
609 ZZ	VV	DD	11.0	12.0	22.8	20.5	0.3	0.3	14.5	14.7
629 ZZ	VV	DD	11.0	12.8	24.0	22.8	0.3	0.3	19.5	19.3
639 ZZ	VV	—	13.0	16.1	26.0	25.6	0.6	0.6	36.5	36

Metric Design With Flange
Bore Diameter 1 – 4 mm

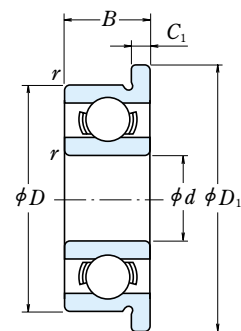

Open Type

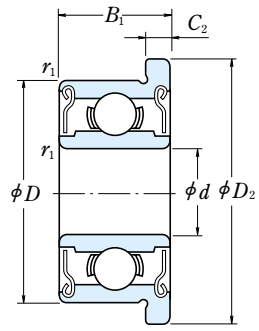

Shielded Type
ZZ · ZZ1

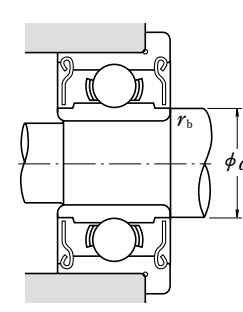
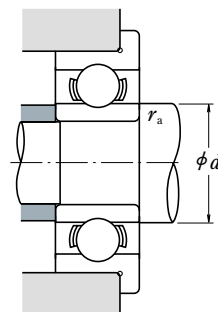

d	Boundary Dimensions (mm)								Basic Load Ratings (N) {kgf}				Limiting Speeds (min ⁻¹)		
	D	D ₁	D ₂	B	B ₁	C ₁	C ₂	r ⁽¹⁾ min.	r ₁ ⁽¹⁾ min.	C _r	C _{0r}	C _r	C _{0r}	Grease Open Z · ZZ	Oil Open Z
1	3	3.8	—	1	—	0.3	—	0.05	—	80	23	8	2.5	130 000	150 000
	4	5	—	1.6	—	0.5	—	0.1	—	140	36	14	3.5	100 000	120 000
1.2	4	4.8	—	1.8	—	0.4	—	0.1	—	138	35	14	3.5	110 000	130 000
1.5	4	5	5	1.2	2	0.4	0.6	0.05	0.05	112	33	11	3.5	100 000	120 000
	5	6.5	6.5	2	2.6	0.6	0.8	0.15	0.15	237	69	24	7	85 000	100 000
	6	7.5	7.5	2.5	3	0.6	0.8	0.15	0.15	330	98	34	10	75 000	90 000
2	5	6.1	6.1	1.5	2.3	0.5	0.6	0.08	0.08	169	50	17	5	85 000	100 000
	5	6.2	6.2	2	2.5	0.6	0.6	0.1	0.1	187	58	19	6	85 000	100 000
	6	7.5	7.5	2.3	3	0.6	0.8	0.15	0.15	330	98	34	10	75 000	90 000
6	7.2	—	2.5	—	0.6	—	0.15	—	—	330	98	34	10	75 000	90 000
	8.2	8.2	2.5	3	0.6	0.6	0.15	0.15	385	127	39	13	63 000	75 000	
	8.5	8.5	2.8	3.5	0.7	0.9	0.15	0.15	385	127	39	13	63 000	75 000	
2.5	6	7.1	7.1	1.8	2.6	0.5	0.8	0.08	0.08	208	74	21	7.5	71 000	80 000
	7	8.5	8.5	2.5	3.5	0.7	0.9	0.15	0.15	385	127	39	13	63 000	75 000
	8	9.2	—	2.5	—	0.6	—	0.2	—	560	179	57	18	60 000	67 000
8	9.5	9.5	2.8	4	0.7	0.9	0.15	0.15	550	175	56	18	60 000	71 000	
	8	9.5	9.5	3	4	0.7	0.9	0.15	0.15	560	179	57	18	60 000	67 000
	9	10.2	10.6	2.5	4	0.6	0.8	0.2	0.15	570	187	58	19	56 000	67 000
9	10.5	10.5	3	5	0.7	1	0.15	0.15	570	187	58	19	56 000	67 000	
	10	11.5	11.5	4	4	1	1	0.15	0.15	630	218	64	22	50 000	60 000
	13	15	15	5	5	1	1	0.2	0.2	1 300	485	133	49	36 000	43 000
4	7	8.2	—	2	—	0.6	—	0.1	—	310	115	32	12	60 000	67 000
	7	—	8.2	—	2.5	—	0.6	—	0.1	255	107	26	11	60 000	71 000
	8	9.2	9.2	2	3	0.6	0.6	0.15	0.1	395	139	40	14	56 000	67 000
9	10.3	10.3	2.5	4	0.6	1	(0.15)	(0.15)	640	225	65	23	53 000	63 000	
10	11.2	11.6	3	4	0.6	0.8	0.2	0.15	710	270	73	28	50 000	60 000	
11	12.5	12.5	4	4	1	1	0.15	0.15	960	345	98	35	48 000	56 000	
12	13.5	13.5	4	4	1	1	0.2	0.2	960	345	98	35	48 000	56 000	
13	15	15	5	5	1	1	0.2	0.2	1 300	485	133	49	40 000	48 000	
16	18	18	5	5	1	1	0.3	0.3	1 730	670	177	68	36 000	43 000	

Note ⁽¹⁾ The values in parentheses are not based on ISO 15.

Remarks When using bearings with a rotating outer ring, please contact NSK if they are shielded.

Bearing Numbers			Abutment and Fillet Dimensions (mm)				Mass (g)	
Open	Shielded	Sealed	d _a min.	d _b max.	r _a max.	r _b max.	approx. Open	Shielded
F 681	—	—	1.4	—	0.05	—	0.04	—
F 691	—	—	1.8	—	0.1	—	0.14	—
MF 41 X	—	—	2.0	—	0.1	—	0.12	—
F 681 X	F 681 XZZ	—	1.9	2.1	0.05	0.05	0.09	0.14
F 691 X	F 691 XZZ	—	2.7	2.5	0.15	0.15	0.23	0.28
F 601 X	F 601 XZZ	—	2.7	3.0	0.15	0.15	0.42	0.52
F 682	F 682 ZZ	—	2.6	2.7	0.08	0.08	0.16	0.22
MF 52 B	MF 52 BZZ	—	2.8	2.7	0.1	0.1	0.21	0.27
F 692	F 692 ZZ	—	3.2	3.0	0.15	0.15	0.35	0.48
MF 62	—	—	3.2	—	0.15	—	0.36	—
MF 72	MF 72 ZZ	—	3.2	3.8	0.15	0.15	0.52	0.56
F 602	F 602 ZZ	—	3.2	3.1	0.15	0.15	0.60	0.71
F 682 X	F 682 XZZ	—	3.1	3.7	0.08	0.08	0.25	0.36
F 692 X	F 692 XZZ	—	3.7	3.8	0.15	0.15	0.51	0.68
MF 82 X	—	—	4.1	—	0.2	—	0.62	—
F 602 X	F 602 XZZ	—	3.7	3.5	0.15	0.15	0.74	0.98
MF 63	MF 63 ZZ	—	3.8	3.7	0.1	0.1	0.27	0.33
F 683 A	F 683 AZZ	—	3.8	4.0	0.1	0.1	0.37	0.53
MF 83	—	—	4.2	—	0.15	—	0.56	—
F 693	F 693 ZZ	—	4.2	4.3	0.15	0.15	0.70	0.97
MF 93	MF 93 ZZ	—	4.6	4.3	0.2	0.15	0.81	1.34
F 603	F 603 ZZ	—	4.2	4.3	0.15	0.15	1.0	1.63
F 623	F 623 ZZ	—	4.2	4.3	0.15	0.15	1.85	1.86
F 633	F 633 ZZ	—	4.6	6.0	0.2	0.2	3.73	3.59
MF 74	—	—	4.8	—	0.1	—	0.29	—
—	MF 74 ZZ	—	—	4.8	—	0.1	—	0.35
MF 84	MF 84 ZZ	—	5.2	5.0	0.15	0.1	0.44	0.63
F 684	F 684 ZZ	—	4.8	5.2	0.1	0.1	0.70	1.14
MF 104 B	MF 104 BZZ	—	5.6	5.9	0.2	0.15	1.13	1.59
F 694	F 694 ZZ	—	5.2	5.6	0.15	0.15	1.91	1.96
F 604	F 604 ZZ	—	5.6	5.6	0.2	0.2	2.53	2.53
F 624	F 624 ZZ	—	5.6	6.0	0.2	0.2	3.38	3.53
F 634	F 634 ZZ1	—	6.0	7.5	0.3	0.3	5.73	5.62

Metric Design With Flange
Bore Diameter 5 – 9 mm

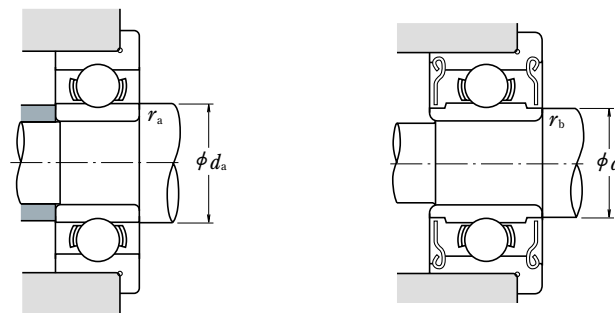
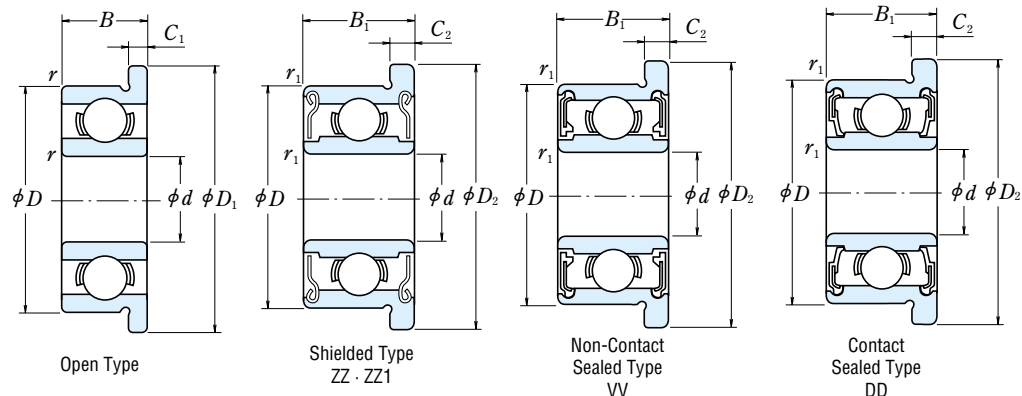

d	Boundary Dimensions (mm)								Basic Load Ratings (N) (kgf)				Limiting Speeds (min ⁻¹)					
	D	D ₁	D ₂	B	B ₁	C ₁	C ₂	r min.	r ₁ min.	C _r	C _{0r}	C _r	C _{0r}	Open Grease Z·ZZ V·VV	Oil D·DD	Open Z		
5	8	9.2	—	2	—	0.6	—	0.1	—	310	120	31	12	53 000	—	63 000		
	8	—	9.2	—	2.5	—	0.6	—	0.1	278	131	28	13	53 000	—	63 000		
	9	10.2	10.2	2.5	3	0.6	0.6	0.15	0.15	430	168	44	17	50 000	—	60 000		
	10	11.2	11.6	3	4	0.6	0.8	0.15	0.15	430	168	44	17	50 000	—	60 000		
11	12.5	12.5	3	5	0.8	1	0.15	0.15	—	715	281	73	29	45 000	—	53 000		
	13	15	15	4	4	1	1	0.2	0.2	1 080	430	110	44	43 000	40 000	50 000		
	14	16	16	5	5	1	1	0.2	0.2	1 330	505	135	52	40 000	38 000	50 000		
	16	18	18	5	5	1	1	0.3	0.3	1 730	670	177	68	36 000	32 000	43 000		
16	19	22	22	6	6	1.5	1.5	0.3	0.3	2 340	885	238	90	32 000	30 000	40 000		
	6	10	11.2	11.2	2.5	3	0.6	0.6	0.15	0.1	495	218	51	22	45 000	—	53 000	
		12	13.2	13.6	3	4	0.6	0.8	0.2	0.15	715	292	73	30	43 000	40 000	50 000	
		13	15	15	3.5	5	1	1.1	0.15	0.15	1 080	440	110	45	40 000	38 000	50 000	
15		17	17	5	5	1.2	1.2	0.2	0.2	1 730	670	177	68	40 000	36 000	45 000		
17	19	19	19	6	6	1.2	1.2	0.3	0.3	2 260	835	231	85	38 000	34 000	45 000		
	19	22	22	6	6	1.5	1.5	0.3	0.3	2 340	885	238	90	32 000	30 000	40 000		
	22	25	25	7	7	1.5	1.5	0.3	0.3	3 300	1 370	335	140	30 000	28 000	36 000		
	7	11	12.2	12.2	2.5	3	0.6	0.6	0.15	0.1	455	201	47	21	43 000	—	50 000	
13		14.2	14.6	3	4	0.6	0.8	0.2	0.15	540	276	55	28	40 000	—	48 000		
14		16	16	3.5	5	1	1.1	0.15	0.15	1 170	510	120	52	40 000	34 000	45 000		
17		19	19	5	5	1.2	1.2	0.3	0.3	1 610	715	164	73	36 000	28 000	43 000		
19	22	22	22	6	6	1.5	1.5	0.3	0.3	2 340	885	238	90	36 000	32 000	43 000		
	22	25	25	7	7	1.5	1.5	0.3	0.3	3 300	1 370	335	140	30 000	28 000	36 000		
	8	12	13.2	13.6	2.5	3.5	0.6	0.8	0.15	0.1	545	274	56	28	40 000	—	48 000	
		14	15.6	15.6	3.5	4	0.8	0.8	0.2	0.15	820	385	83	39	38 000	32 000	45 000	
16		18	18	4	5	1	1.1	0.2	0.2	1 610	710	164	73	36 000	30 000	43 000		
19		22	22	6	6	1.5	1.5	0.3	0.3	2 240	910	228	93	36 000	28 000	43 000		
22	25	25	7	7	1.5	1.5	0.3	0.3	3 300	1 370	335	140	34 000	28 000	40 000			
	9	17	19	19	4	5	1	1.1	0.2	0.2	1 330	665	136	68	36 000	24 000	43 000	
20		23	23	6	6	1.5	1.5	0.3	0.3	1 720	840	175	86	34 000	24 000	40 000		

Bearing Numbers				Abutment and Fillet Dimensions (mm)				Mass (g)	
Open	Shielded	Sealed		d _a min.	d _b max.	r _a max.	r _b max.	approx. Open	Shielded
MF 85	—	—	—	5.8	—	0.1	—	0.33	—
—	MF 85 ZZ	—	—	—	5.8	—	0.1	—	0.41
MF 95	MF 95 ZZ1	—	—	6.2	6.0	0.15	0.15	0.59	0.66
MF 105	MF 105 ZZ	—	—	6.2	6.0	0.15	0.15	1.05	1.46
F 685	F 685 ZZ	—	—	6.2	6.2	0.15	0.15	1.37	2.18
F 695	F 695 ZZ	VV	DD	6.6	6.6	0.2	0.2	2.79	2.84
F 605	F 605 ZZ	—	DD	6.6	6.9	0.2	0.2	3.9	3.85
F 625	F 625 ZZ1	VV	DD	7.0	7.5	0.3	0.3	5.37	5.27
F 635	F 635 ZZ1	VV	DD	7.0	8.5	0.3	0.3	9.49	9.49
MF 106	MF 106 ZZ1	—	—	7.2	7.0	0.15	0.1	0.65	0.77
MF 126	MF 126 ZZ	—	DD	7.6	7.2	0.2	0.15	1.38	1.94
F 686 A	F 686 AZZ	VV	DD	7.2	7.4	0.15	0.15	2.25	3.04
F 696	F 696 ZZ1	VV	DD	7.6	7.9	0.2	0.2	4.34	4.26
F 606	F 606 ZZ	VV	DD	8.0	8.2	0.3	0.3	6.58	6.61
F 626	F 626 ZZ1	VV	DD	8.0	8.5	0.3	0.3	9.09	9.09
F 636	F 636 ZZ	VV	DD	8.0	10.5	0.3	0.3	14.6	14.7
MF 117	MF 117 ZZ	—	—	8.2	8.0	0.15	0.1	0.72	0.82
MF 137	MF 137 ZZ	—	—	8.6	9.0	0.2	0.15	1.7	2.23
F 687	F 687 ZZ1	VV	DD	8.2	8.5	0.15	0.15	2.48	3.37
F 697	F 697 ZZ1	VV	DD	9.0	10.2	0.3	0.3	5.65	5.65
F 607	F 607 ZZ1	VV	DD	9.0	9.1	0.3	0.3	8.66	8.66
F 627	F 627 ZZ	VV	DD	9.0	10.5	0.3	0.3	14.2	14.2
MF 128	MF 128 ZZ1	—	—	9.2	9.0	0.15	0.1	0.82	1.15
MF 148	MF 148 ZZ	VV	DD	9.6	9.2	0.2	0.15	2.09	2.39
F 688 A	F 688 AZZ	VV	DD	9.6	10.2	0.2	0.2	3.54	4.47
F 698	F 698 ZZ	VV	DD	10.0	10.0	0.3	0.3	8.35	8.3
F 608	F 608 ZZ	VV	DD	10.0	10.5	0.3	0.3	13.4	13.5
F 689	F 689 ZZ1	VV	DD	10.6	11.5	0.2	0.2	3.97	4.91
F 699	F 699 ZZ1	VV	DD	11.0	12.0	0.3	0.3	9.51	9.51

Remarks When using bearings with a rotating outer ring, please contact NSK if they are shielded.

Inch Design

Bore Diameter 1.016 – 9.525 mm

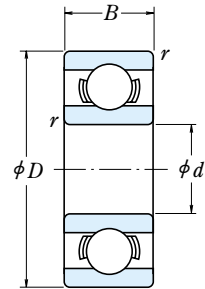

Open Type

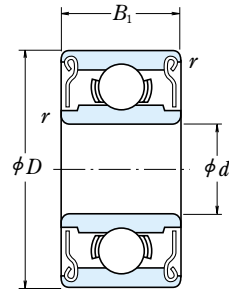

Shielded Type
ZZ · ZJS

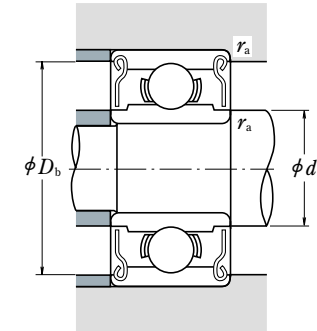
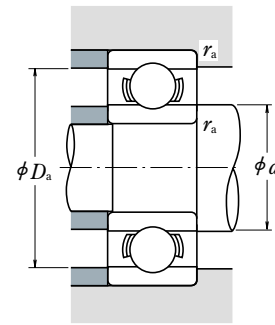

d	Boundary Dimensions (mm)				Basic Load Ratings (N) (kgf)				Limiting Speeds (min ⁻¹)		Bearing Open
	D	B	B ₁	r min.	C _r	C _{0r}	C _r	C _{0r}	Grease Open Z · ZZ	Oil Open Z	
1.016	3.175	1.191	—	0.1	80	23	8	2.5	130 000	150 000	R 09
1.191	3.967	1.588	2.380	0.1	138	35	14	3.5	110 000	130 000	R 0
1.397	4.762	1.984	2.779	0.1	231	66	24	6.5	90 000	110 000	R 1
1.984	6.350	2.380	3.571	0.1	310	108	32	11	67 000	80 000	R 1-4
2.380	4.762	1.588	—	0.1	188	60	19	6	80 000	95 000	R 133
	4.762	—	2.380	0.1	143	52	15	5.5	80 000	95 000	—
	7.938	2.779	3.571	0.15	550	175	56	18	60 000	71 000	R 1-5
3.175	6.350	2.380	2.779	0.1	283	95	29	9.5	67 000	80 000	R 144
	7.938	2.779	3.571	0.1	560	179	57	18	60 000	67 000	R 2-5
	9.525	2.779	3.571	0.15	640	225	65	23	53 000	63 000	R 2-6
3.967	9.525	3.967	3.967	0.3	630	218	64	22	56 000	67 000	R 2
	12.700	4.366	4.366	0.3	640	225	65	23	53 000	63 000	R 2A
4.762	7.938	2.779	3.175	0.1	360	149	37	15	53 000	63 000	R 155
	9.525	3.175	3.175	0.1	710	270	73	28	50 000	60 000	R 156
	12.700	3.967	4.978	0.3	1 300	485	133	49	43 000	53 000	R 166 R 3
6.350	9.525	3.175	3.175	0.1	420	204	43	21	48 000	56 000	R 168B
	12.700	3.175	4.762	0.15	1 080	440	110	45	40 000	50 000	R 188
	15.875	4.978	4.978	0.3	1 610	660	164	68	38 000	45 000	R 4B
7.938	19.050	5.558	7.142	0.4	2 620	1 060	267	108	36 000	43 000	R 4AA
	12.700	3.967	3.967	0.15	540	276	55	28	40 000	48 000	R 1810
9.525	22.225	5.558	7.142	0.4	3 350	1 410	340	144	32 000	38 000	R 6

- Remarks 1. When using bearings with a rotating outer ring, please contact NSK if they are shielded.
2. Bearings with double shields (ZZ, ZJS) are also available with single shields (Z, ZS).

Numbers	Abutment and Fillet Dimensions (mm)					Mass (g)		
	Shielded	d _a min.	d _b max.	D _a max.	D _b min.	r _a max.	Open	approx. Shielded
—	—	1.9	—	2.3	—	0.1	0.04	—
R 0 ZZ	—	2.0	1.9	3.1	3.5	0.1	0.09	0.11
R 1 ZZ	—	2.2	2.3	3.9	4.1	0.1	0.15	0.19
R 1-4 ZZ	—	2.8	3.9	5.5	5.9	0.1	0.35	0.50
—	—	3.2	—	3.9	—	0.1	0.10	—
R 133 ZJS	—	—	3.0	—	4.2	0.1	—	0.13
R 1-5 ZZ	—	3.6	4.1	6.7	7.0	0.15	0.60	0.72
R 144 ZZ	—	4.0	3.9	5.5	5.9	0.1	0.25	0.27
R 2-5 ZZ	—	4.0	4.3	7.1	7.3	0.1	0.55	0.72
R 2-6 ZJS	—	4.4	4.6	8.3	8.2	0.15	0.96	1.13
R 2 ZZ	—	5.2	4.8	7.5	8.0	0.3	1.36	1.39
R 2A ZZ	—	5.2	4.6	10.7	8.2	0.3	3.3	3.23
R 155 ZJS	—	4.8	5.5	7.1	7.3	0.1	0.51	0.56
R 156 ZJS	—	5.6	5.5	7.1	7.3	0.1	0.39	0.42
R 166 ZZ	—	5.6	5.9	8.7	8.8	0.1	0.81	0.85
R 3 ZZ	—	6.8	6.5	10.7	11.2	0.3	2.21	2.79
R 168 BZZ	—	7.2	7.0	8.7	8.9	0.1	0.58	0.62
R 188 ZZ	—	7.6	7.4	11.5	11.6	0.15	1.53	2.21
R 4B ZZ	—	8.4	8.4	13.8	13.8	0.3	4.5	4.43
R 4AA ZZ	—	9.4	9.0	16.0	16.6	0.4	7.48	9.17
R 1810 ZZ	—	9.2	9.0	11.5	11.6	0.15	1.56	1.48
R 6 ZZ	—	12.6	11.9	19.2	20.0	0.4	9.02	11

Inch Design With Flange
Bore Diameter 1.191 – 9.525 mm

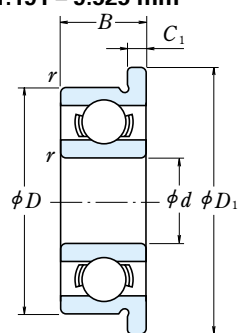

Open Type

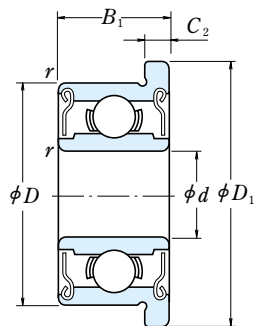

Shielded Type
ZZ · ZS

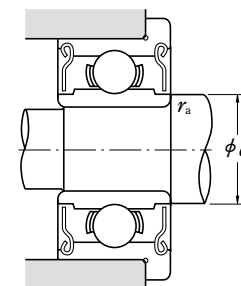
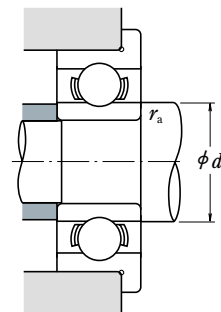

d	Boundary Dimensions (mm)							Basic Load Ratings (N) (kgf)			
	D	D ₁	B	B ₁	C ₁	C ₂	r min.	C _r	C _{0r}	C _r	C _{0r}
1.191	3.967	5.156	1.588	2.380	0.330	0.790	0.1	138	35	14	3.5
1.397	4.762	5.944	1.984	2.779	0.580	0.790	0.1	231	66	24	6.5
1.984	6.350	7.518	2.380	3.571	0.580	0.790	0.1	310	108	32	11
2.380	4.762	5.944	1.588	—	0.460	—	0.1	188	60	19	6
	4.762	5.944	—	2.380	—	0.790	0.1	143	52	15	5.5
	7.938	9.119	2.779	3.571	0.580	0.790	0.15	550	175	56	18
3.175	6.350	7.518	2.380	2.779	0.580	0.790	0.1	283	95	29	9.5
	7.938	9.119	2.779	3.571	0.580	0.790	0.1	560	179	57	18
	9.525	10.719	2.779	3.571	0.580	0.790	0.15	640	225	65	23
	9.525	11.176	3.967	3.967	0.760	0.760	0.3	630	218	64	22
3.967	7.938	9.119	2.779	3.175	0.580	0.910	0.1	360	149	37	15
4.762	7.938	9.119	2.779	3.175	0.580	0.910	0.1	360	149	37	15
	9.525	10.719	3.175	3.175	0.580	0.790	0.1	710	270	73	28
	12.700	14.351	4.978	4.978	1.070	1.070	0.3	1 300	485	133	49
6.350	9.525	10.719	3.175	3.175	0.580	0.910	0.1	420	204	43	21
	12.700	13.894	3.175	4.762	0.580	1.140	0.15	1 080	440	110	45
	15.875	17.526	4.978	4.978	1.070	1.070	0.3	1 610	660	164	68
7.938	12.700	13.894	3.967	3.967	0.790	0.790	0.15	540	276	55	28
9.525	22.225	24.613	7.142	7.142	1.570	1.570	0.4	3 350	1 410	340	144

Limiting Speeds (min ⁻¹)		Bearing Numbers		Abutment and Fillet Dimensions (mm)			Mass (g)	
Grease Open Z · ZZ	Oil Open Z	Open	Shielded	d _a min.	d _b max.	r _a max.	Open	approx. Shielded
110 000	130 000	FR 0	FR 0 ZZ	2.0	1.9	0.1	0.11	0.16
90 000	110 000	FR 1	FR 1 ZZ	2.2	2.3	0.1	0.20	0.25
67 000	80 000	FR 1-4	FR 1-4 ZZ	2.8	3.9	0.1	0.41	0.58
80 000	95 000	FR 133	—	3.2	—	0.1	0.13	—
80 000	95 000	—	FR 133 ZS	—	3.0	0.1	—	0.19
60 000	71 000	FR 1-5	FR 1-5 ZZ	3.6	4.1	0.15	0.68	0.82
67 000	80 000	FR 144	FR 144 ZZ	4.0	3.9	0.1	0.31	0.35
60 000	67 000	FR 2-5	FR 2-5 ZZ	4.0	4.3	0.1	0.62	0.81
53 000	63 000	FR 2-6	FR 2-6 ZS	4.4	4.6	0.15	1.04	1.25
56 000	67 000	FR 2	FR 2 ZZ	5.2	4.8	0.3	1.51	1.55
53 000	63 000	FR 155	FR 155 ZS	4.8	5.5	0.1	0.59	0.67
53 000	63 000	FR 156	FR 156 ZS	5.6	5.5	0.1	0.47	0.53
50 000	60 000	FR 166	FR 166 ZZ	5.6	5.9	0.1	0.90	0.98
43 000	53 000	FR 3	FR 3 ZZ	6.8	6.5	0.3	2.97	3.09
48 000	56 000	FR 168B	FR 168 BZZ	7.2	7.0	0.1	0.66	0.75
40 000	50 000	FR 188	FR 188 ZZ	7.6	7.4	0.15	1.64	2.49
38 000	45 000	FR 4B	FR 4B ZZ	8.4	8.4	0.3	4.78	4.78
40 000	48 000	FR 1810	FR 1810 ZZ	9.2	9.0	0.15	1.71	1.63
32 000	38 000	FR 6	FR 6 ZZ	12.6	11.9	0.4	10.1	12.1

Remarks 1. When using bearings with a rotating outer ring, please contact NSK if they are shielded.
2. Bearings with double shields (ZZ, ZS) are also available with single shields (Z, ZS).